

OZCO Project #313 - 12x12 Pergola Patio Shade Structure C

this project utilizes Project
#311 as base structure.

see OZCO website for
further information

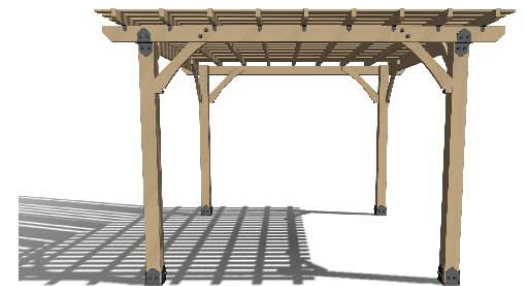

OZCO BUILDING PRODUCTS



Printing Documents from ISSUU

Unfortunately, there is currently no way to print content directly through issuu. To print a publication, you will need to download it and print it from your computer.

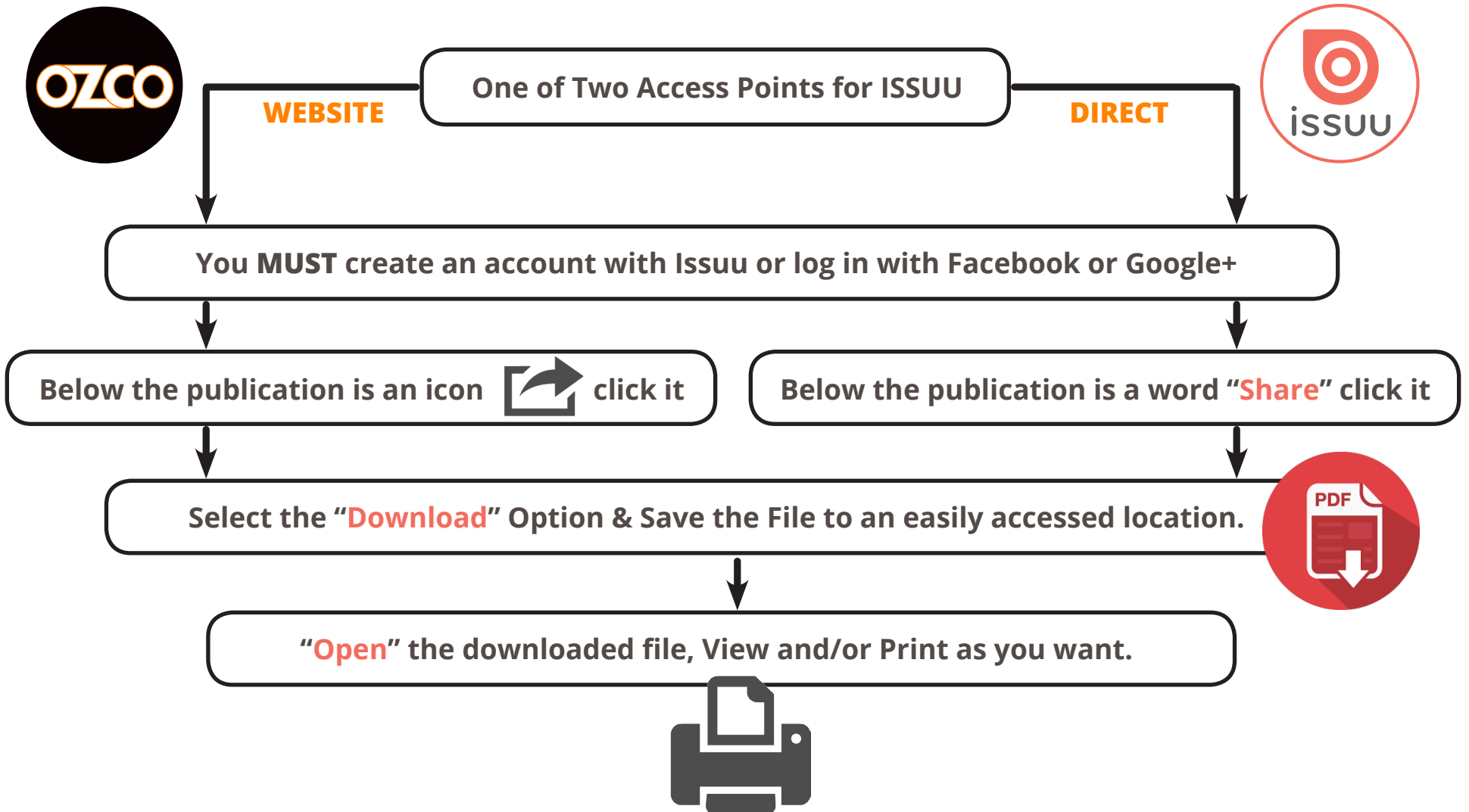

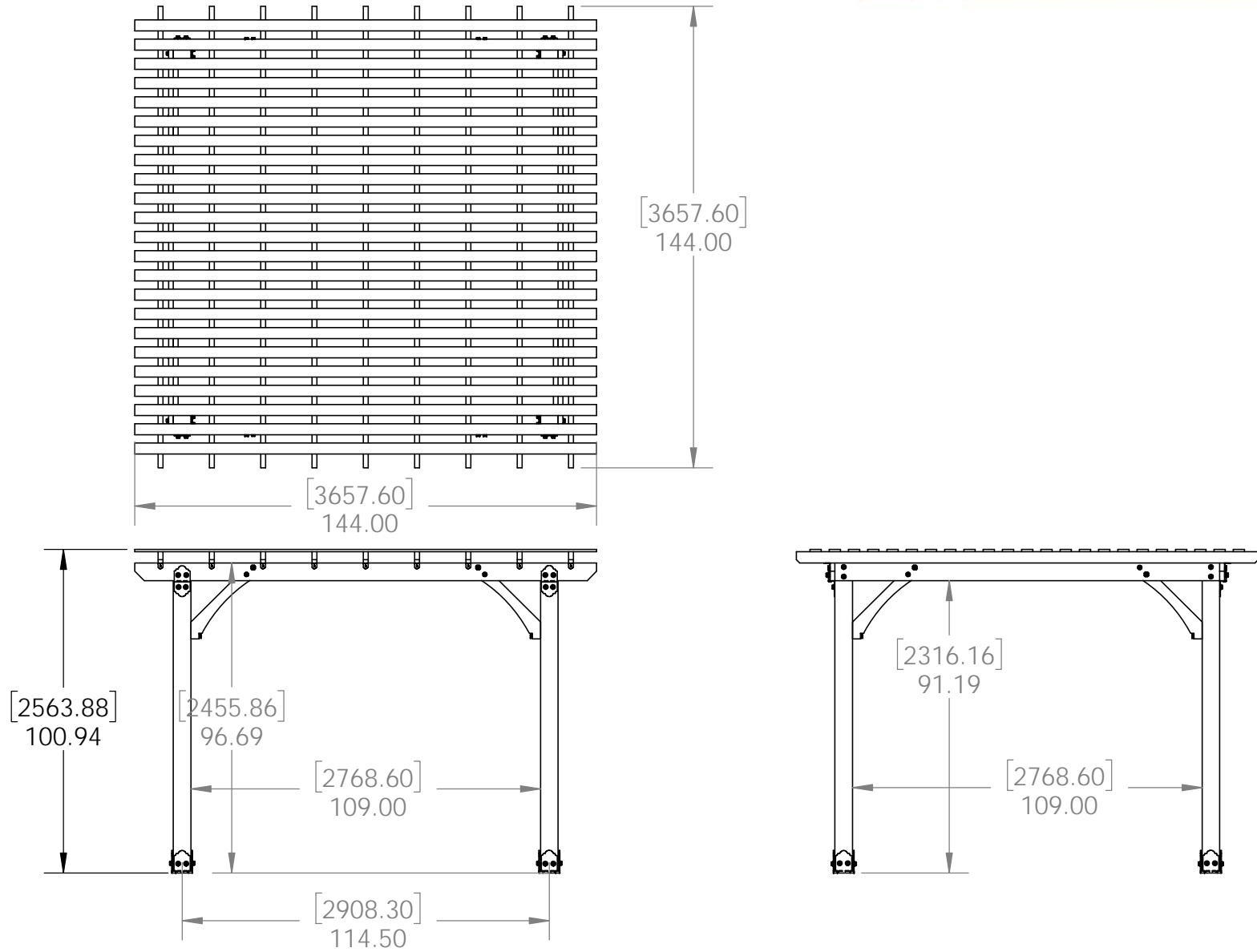

OZCO Project #313 - 12x12 Pergola Patio Shade Structure C.pdf

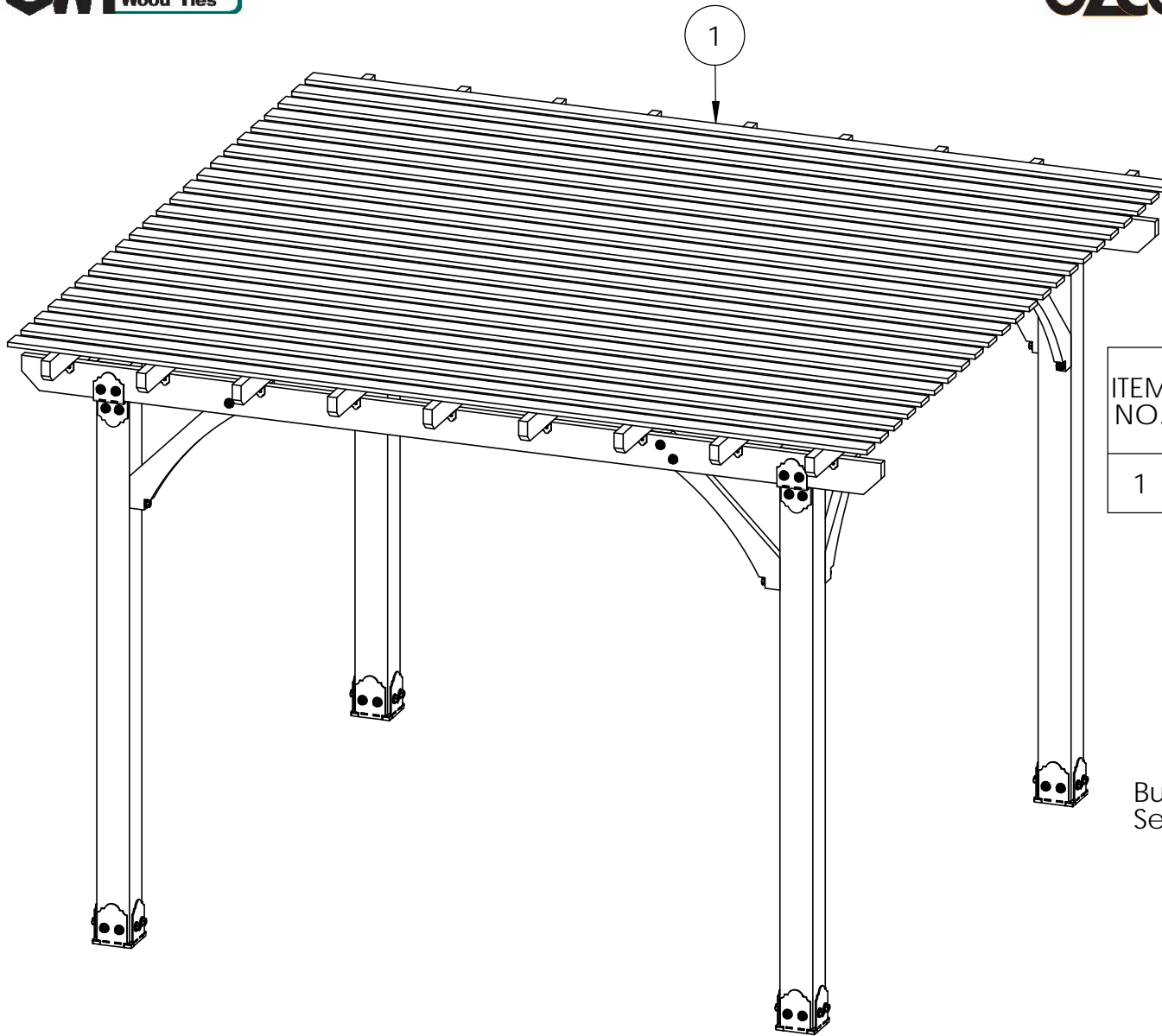

ITEM NO.	QTY.	PART NUMBER	DESCRIPTION
1	23	1x4 Board	1x4x144.00

Build Project #311, then add Purlins
Secure with nails or screws

OZCO Project #313 - 12x12 Pergola Patio Shade Structure C.pdf

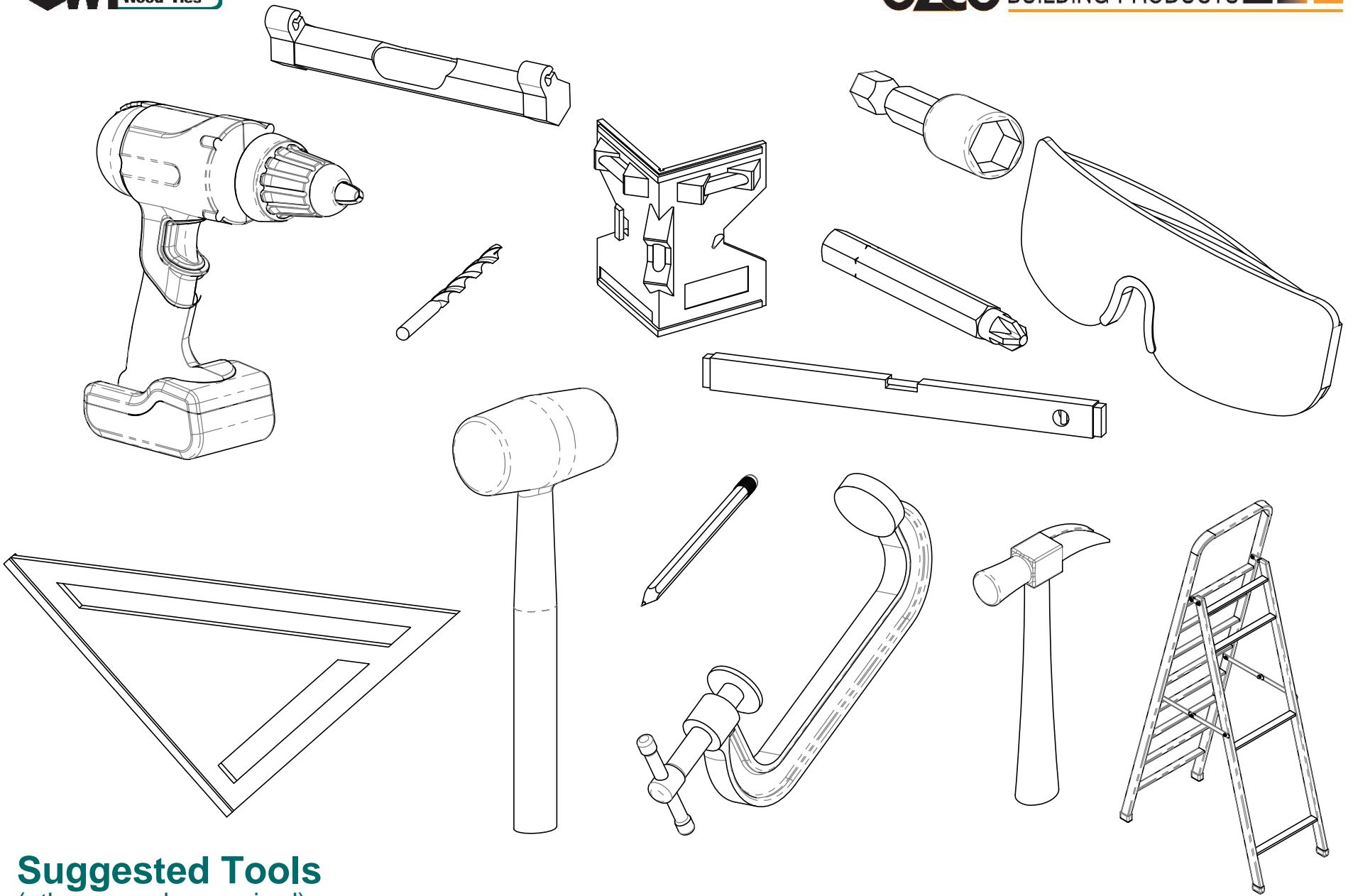

Suggested Tools
(others may be required)

**OZCO Project #313 - 12x12 Pergola Patio
Shade Structure C**

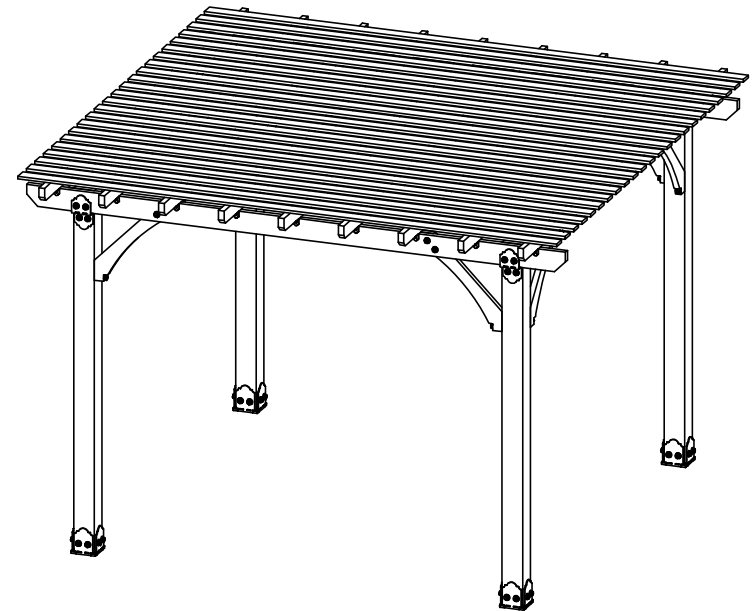
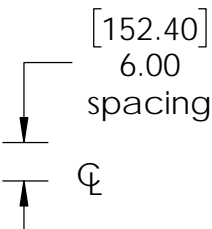
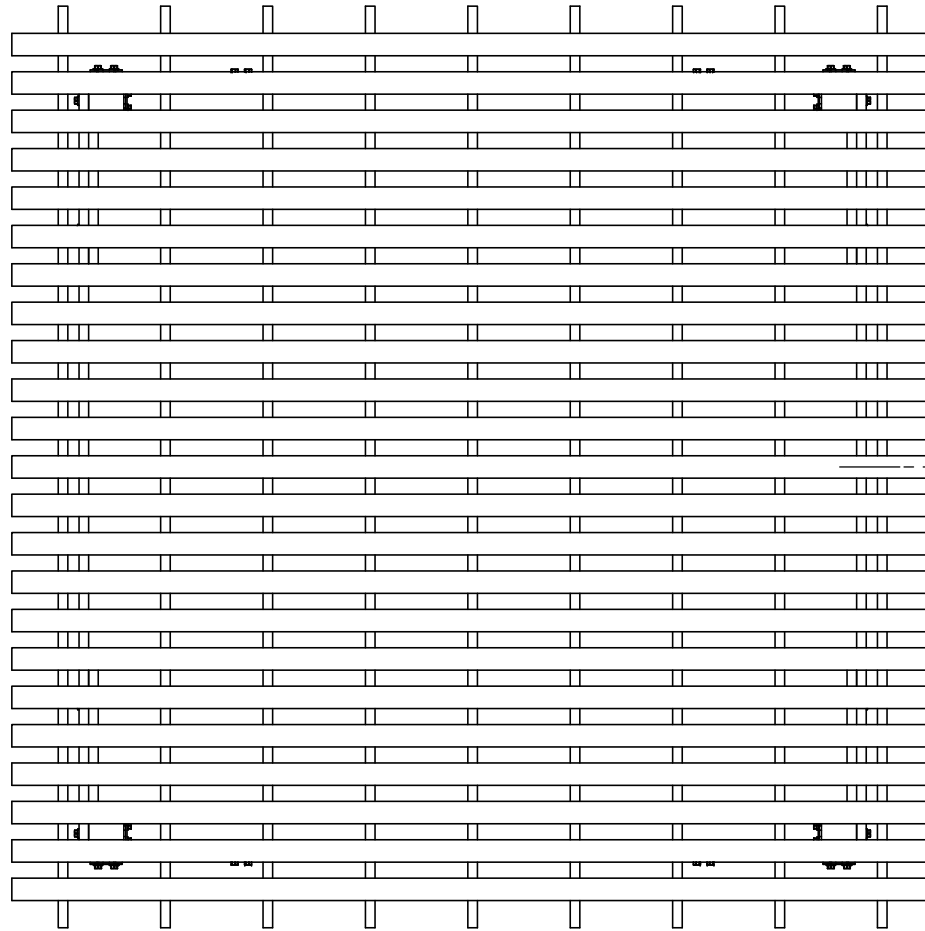

OZCO Project #313 - 12x12 Pergola Patio Shade Structure C.pdf

OZCO Project #313 - 12x12 Pergola Patio Shade Structure C

V1.00 - Installation Instructions effective May 1, 2015 and reflects information that available as of April 10, 2014. This information is updated periodically and should not be relied upon after May 1, 2015. Please visit www.OZCOBP.com to get current information